

AE Series of LEDs Bargraph Panel Meter

AE151SCK29Z

51 Segments Single Bargraph Panel Meter (24X96) With Alarm Control

AE

SCK

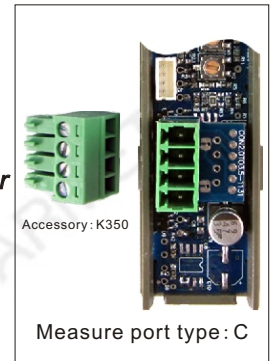
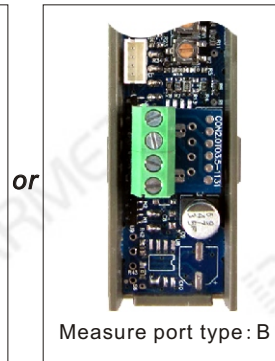
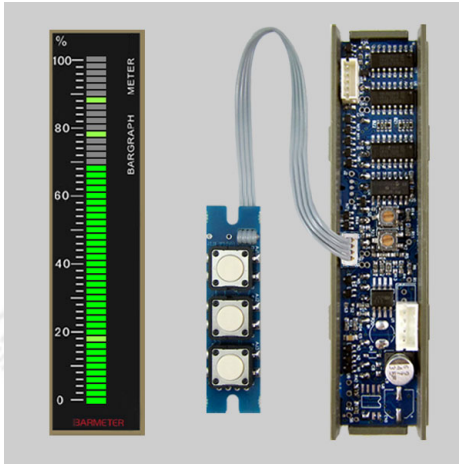

SPECIFICATIONS

2012.07

FEATURES

- Rectangle windows technics with soft tint.
- Embedded structure meter, easy to install.
- Used in measure and display DC value.
- Retardation of alarm exit can be set.
- Wide range of power supply and low power consumption.
- Highlight cursor segments and alarm output control.
- Self keyboard can set cursor, brightness and exit retardation etc.

[Http://www.barmeter.com](http://www.barmeter.com)

DESCRIPTIONS

- **Input Mode:** Current, Voltage, Rheostat
- **Max. Input Over Capability:** 2× Input value
- **Input Resistance Via for Volt Meter:** > 500KΩ
- **Resistance Via for Current Meter:** < 50Ω
- **Rheostat's Input Range:** 2-10KΩ
- **Measuring Accuracy:**

1. Current, Voltage	± 0.5% F. S. ± 1Segment
2. Rheostat	± 1.0% F. S. ± 1Segment
- **Effective Beam Number:** 51 Segments
- **Bargraph Length:** 75 mm
- **Segment Pitch:** 1.5 mm
- **Zero and Full Adjust Ratio :** ± 10~20%
- **Alarm Output Driver :** 80mA (OC)
- **Power Supply and Range :**
 - Normal : DC5V ± 10%
 - Optional : DC12V (10~15V)
 - DC24V (20~28V)
- **Power Consumption:** ≤ 500mW (F. S.)
- **Environment :** -30~70°C & < 85%RH
- **Insulating Intension (Isolated Power):** DC1000V 1min

MODEL AND ORDERING CODE

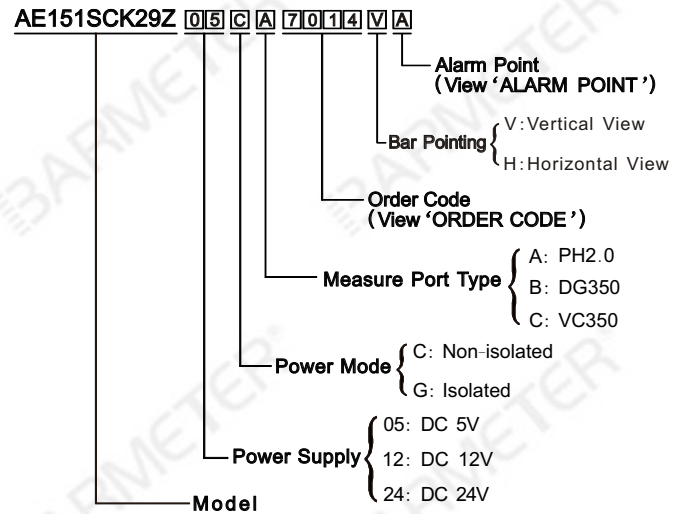

ORDER CODE

Bar color	0~5V	1~5V	0~10mA	4~20mA	0~10V	Rheostat 2~10KΩ
Red	7011	7012	7013	7014	7015	7016
Green	7021	7022	7023	7024	7025	7026
Yellow	7031	7032	7033	7034	7035	7036

ALARM POINT

ALARM POINT	Single Alarm		Two Alarm		Three Alarm
	UA	LA	UA, LA	SA, UA	SA, UA, LA
CODE	A	B	C	D	E

NOTES

SA=super limit alarm point , UA=upper limit alarm point
LA=lower limit alarm point

AE Series of LEDs Bargraph Panel Meter

AE151SCK29Z

51 Segments Single Bargraph Panel Meter (24X96) With Alarm Control

AE

SCK

■ DIMENSION

• MODULE

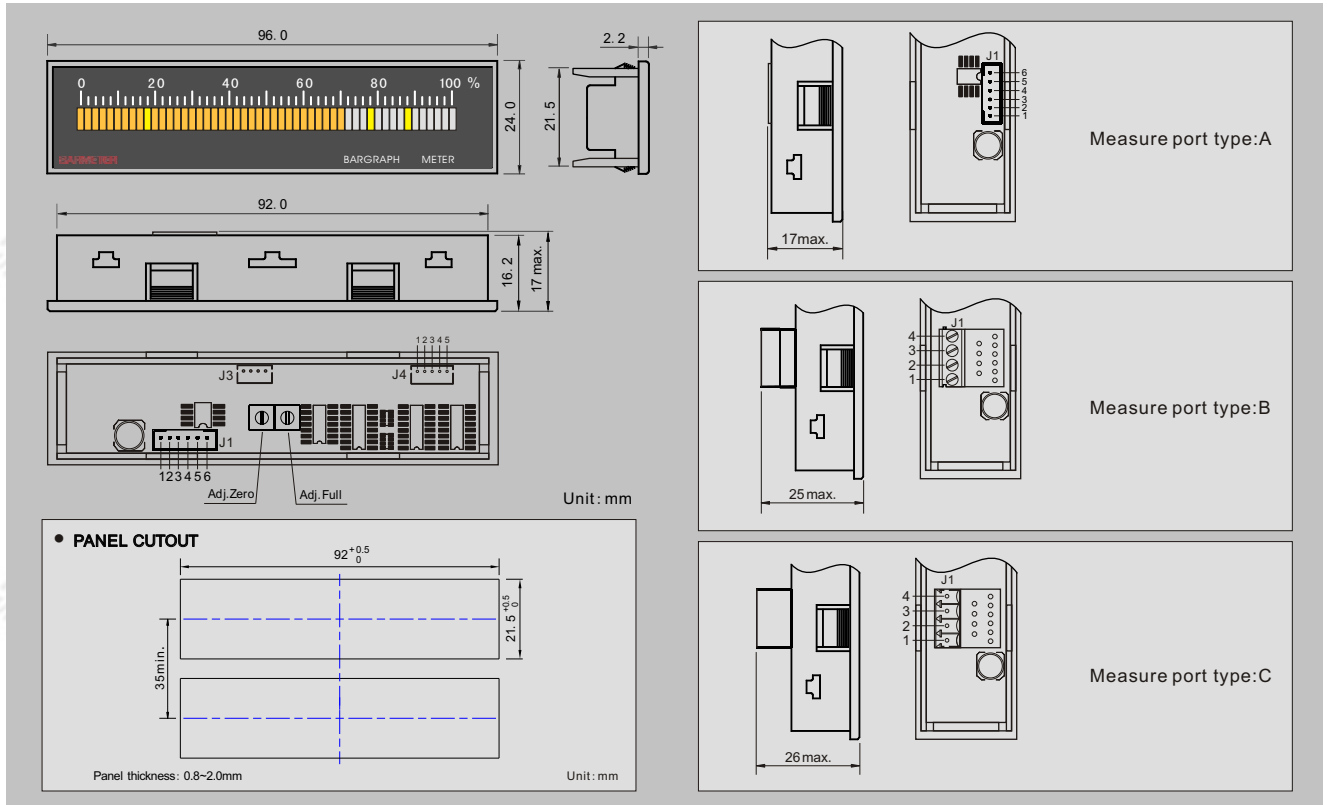

• KEYBOARD

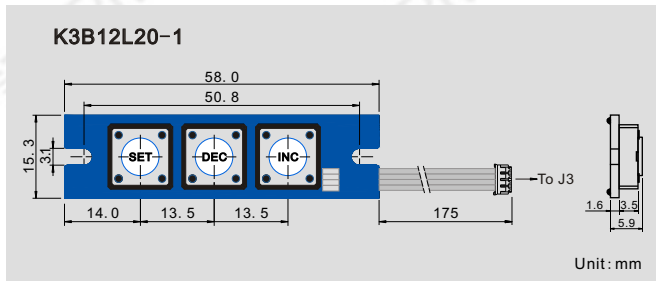

■ ALARM PORT PINOUT (J4)

No.	Symbol	Wire color	Definition
1	GND	Black	0V Output
2	LA	Yellow	Alarm Output, 80mA(OC)
3	UA	White	Alarm Output, 80mA(OC)
4	SA	Blue	Alarm Output, 80mA(OC)
5	Vcc	Red	+5V/60mA Output

When order single or two alarm product, the connector wire will be different because of the different leading-out port.

• CONNECTOR

WZH-155L20-2 (When order three alarm product)

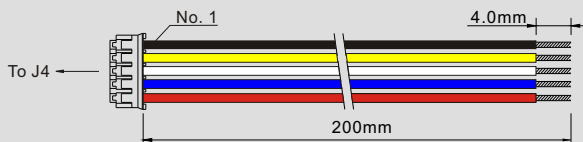

■ MEASURE PORT PINOUT (J1)

No.	Symbol	Wire color	Definition	Note
1	PS-	Black	Power Supply Negative	
2	IN(L)	Blue	Input Low	
3	IN(H)	Yellow	Input High	
4	PS+	Red	Power Supply Positive	
5	Vref	Purple	Vref Output	*
6	GND	White	Internal Ground	*

* When order '70X6' (View 'ORDER CODE')

• CONNECTOR (When the measure port choose type A)

WPH-204L25-1

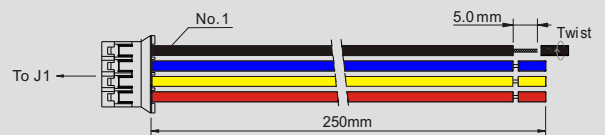

WPH-206L25-1 (When order '70X6')

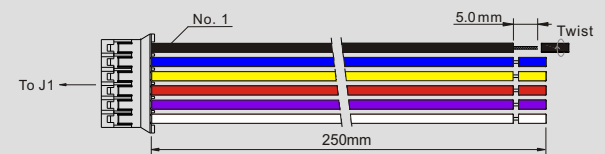

AE Series of LEDs Bargraph Panel Meter

AE151SCK29Z

51 Segments Single Bargraph Panel Meter (24X96) With Alarm Control

AE

SCK

- CONNECTOR (When the measure port choose type C)

K350-4

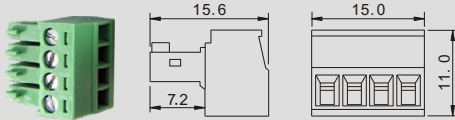

K350-6 (When order '70X6')

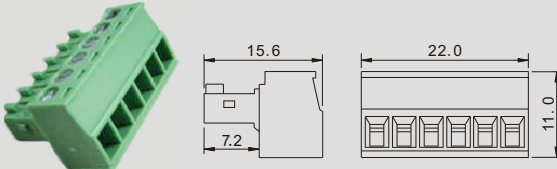

Unit: mm

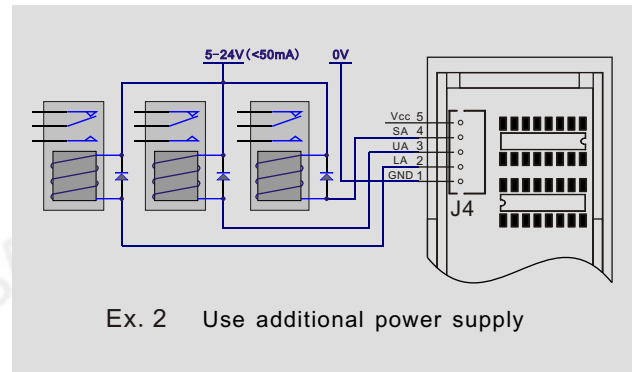

THE APPLICATION OF SIGNAL INPUT

- The Application of Voltage and Current Input

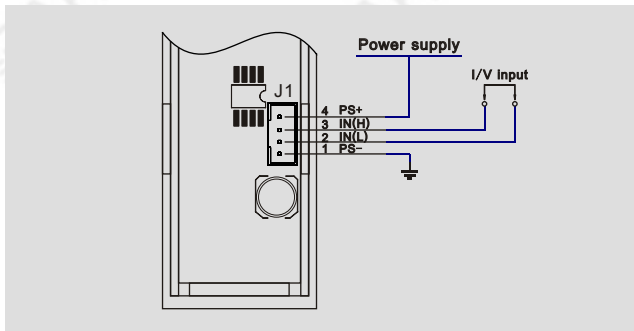

- The Application of Rheostat Input

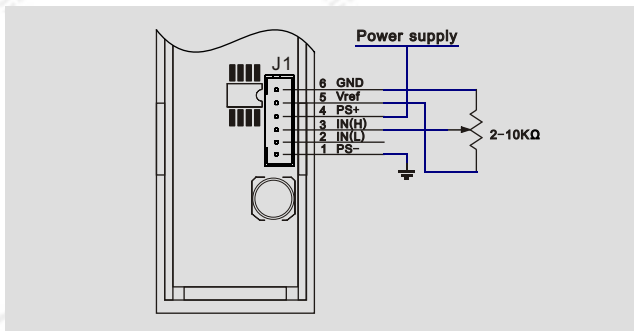

THE APPLICATION OF ALARM CONTROL

- The Example of External Relay and Others

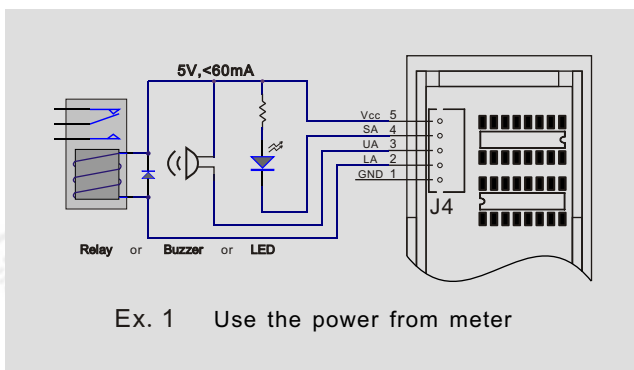

OPERATING INSTRUCTIONS

Take 3 Alarm Points for Example

1. Bar Brightness Setting

The module will enter into the bar brightness setting state when press the key 'INC '+' DEC' for 3 seconds in the measurement state. Meanwhile, the bar will present zebra-stripe as Fig.1, then press the 'INC' or 'DEC' can control the bar's brightness (there are 8 grades). The module will exit and go into the measurement state when press the 'SET' for 3 seconds or no key operate for 10 seconds.

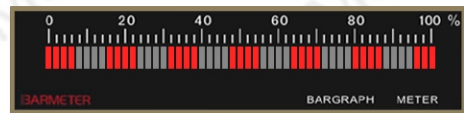

Fig. 1

2. The Cursor and Setting

2.1 The Cursor

The module has three cursors which have memory function and brighter than normal segments (as Fig.2). They are alarm control point of 'super limit', 'upper limit' and 'lower limit'.

The alarm control point can be set the exit delay separately.

The alarm control point can be set from 3rd to 51st segments, upper limit can be set from 2nd to 50th segments, lower limit can be set from 1st to 49th. And they must meet the following condition: super limit > upper limit > lower limit.

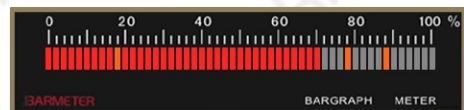

Fig. 2

2.2 Cursor Setting

The module will enter into the cursor setting state when press the key ' SET ' for 3 seconds in the measurement state. Press the ' SET ' can switch to the cursor which need to set and the cursor that being set will blink. Meanwhile, press the key ' INC ' once, the cursor which being set will increase one segment, press the key ' DEC ' once, it will decrease one segment and if hold down the key ' INC ' or ' DEC ', the cursor segment will increase or decrease continuously. Once the setting completed, the module will exit and go into the measurement state when press the ' SET ' for 3 seconds or no key operate for 10 seconds.

2.3 Cursor Disappear (Shut)

In the measurement state, press the key ' INC ' repeatedly, the cursor will disappear or reappear (as Fig.3 and Fig.4).

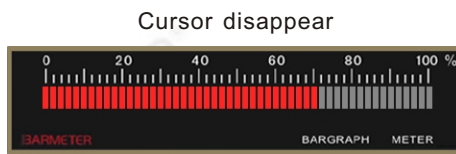

Fig. 3

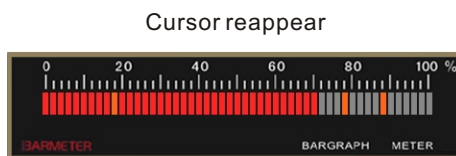

Fig. 4

3. The Retardation of Alarm Exit and Setting

3.1 Retardation of Alarm Exit

The bar will blink slowly to alarm at the moment of the measured value higher(lower) than the value of upper (lower) limit cursor. The bar will blink fast to alarm at the moment of the measured value higher than the value of super limit cursor.

Recovery from the alarm status is ' alarm exit '. The alarm exit can delay some value to operate, which is called ' retardation of alarm exit '. The cursors of three alarm control points all have 4 grades retardation which can be set, so users can set them separately according to their needs.

3.2 Retardation of Alarm Exit Setting

The module will enter into the retardation of alarm exit setting state when press the key ' SET ' + ' INC ' for 3 seconds in the measurement state. Then the bar will present a state like Fig.5-6. At the top, middle and bottom of the bar display contiguous segments which can increase or decrease and they match to the grades of retardation of alarm exit of ' super limit ', ' upper limit ' and ' lower limit '. (Alarm exit has 4 grades, they are 0,1,2 and 3, each segment means one grade. From low to high, each grade represent the retardation of one segment, 0th grade means alarm exit without delay.) Press ' SET ' repeatedly can switch among the top, middle and bottom segments part, then the toppest segment of selected part will blink, after that, press ' INC ' or ' DEC ' can elevate or reduce grades. Once the setting completed, the module will quit and go into the measurement state when press the ' SET ' for 3 seconds or no key operate for 10 seconds.

The retardation of super limit, upper limit and lower limit are all on the 3rd grade.

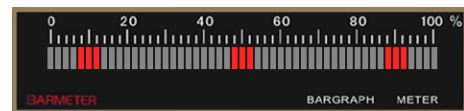

Fig. 5

Change the super limit's retardation to the 2nd grade, lower limit to the 0th grade.

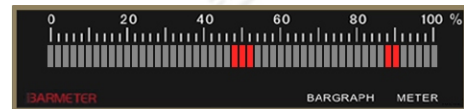

Fig. 6

4. Measure and Control Output

In the measurement state, the bar up and down are controlled by the input analog signal, the relevant control output port of ' SA ', ' UA ' and ' LA ' will output a low level(OC, 80mA) when the toppest segment of the bar higher than the super limit or upper limit or lower than the lower limit.

5. Return to the Default State

The module will ready to restore default state when press the ' SET ' and turn on the power simultaneously. Meanwhile, the whole bar will light up and blink. Then press the ' SET ' for 3 seconds, system will return to the default state.(The module will quit and go into the measurement state if there are no key operate for 10 seconds.) The default state is that the brightness of bar is on the 4th grade, three cursors are at the 10th, 40th and 45th segment, retardation of alarm exit are all on the 0th grade.